

Operating Instructions
Bedienungsanleitung
Mode d'emploi
Instrucciones de manejo

METTLER TOLEDO

METTLER TOLEDO
AE160
AE100

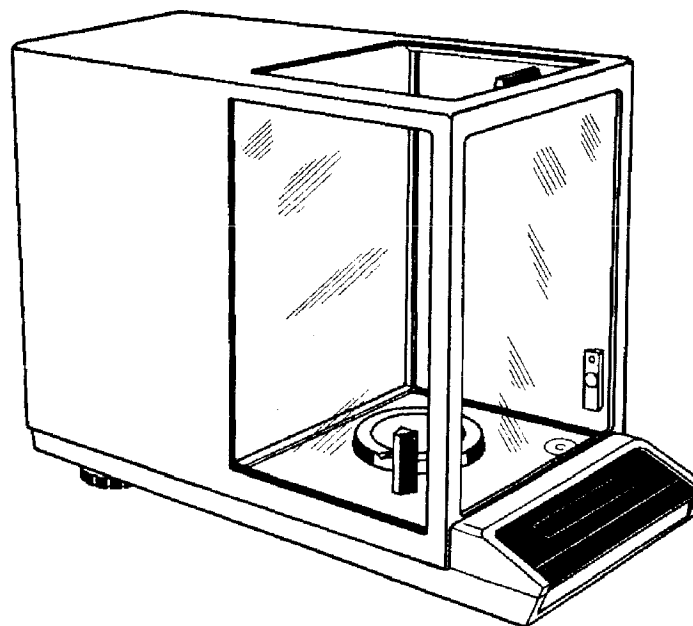

OPERATING INSTRUCTIONS

Page 2

English

BEDIENUNGSANLEITUNG

Seite 16

Deutsch

MODE D'EMPLOI

Page 30

Français

INSTRUCCIONES DE MANEJO

Página 44

Español

METTLER TOLEDO AE160

Weighing range 0...162 g
Readability 0.1 mg

METTLER TOLEDO AE100

Weighing range 0...109 g
Readability 0.1 mg

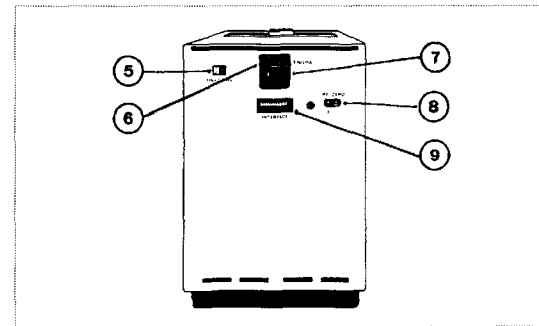
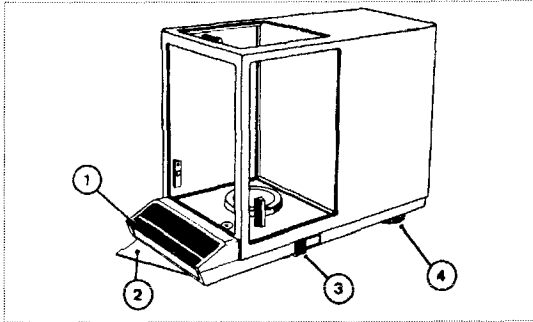

Operating elements and connections

- 1 Single control bar
- 2 Brief operating instructions
- 3 Calibration lever
- 4 Leveling screws
- 5 Operating voltage selector switch
- 6 Fuse holder
- 7 Power connector
- 8 Connector for foot pedal/hand switch
- 9 Connector for data interface

<u>TABLE OF CONTENTS</u>	<u>Page</u>
<u>Preparations for setting up the balance</u>	
Checking the voltage, setting up the balance	4
<u>Operation</u>	
Switching the balance on; taring	5
Single control bar (flow chart)	6
Calibrating	7
Integration time settings and stability detector	8
Weighing-in with DeltaDisplay	9
<u>Additional balance functions</u>	
Weighing below the balance; remote control	10
<u>Care and maintenance</u>	10
<u>Accessories</u>	11
<u>What's wrong if ...?</u>	12
<u>Technical specifications</u>	14

PREPARATIONS: How to check the voltage setting and set up the balance.

Before the balance is set up for the first time, the operating voltage must be set to conform to the line voltage to which the balance will be connected.

Select a suitable location for your balance; this helps increase operating efficiency.

Install the pan on the balance.

Level the balance and check leveling on a regular basis.

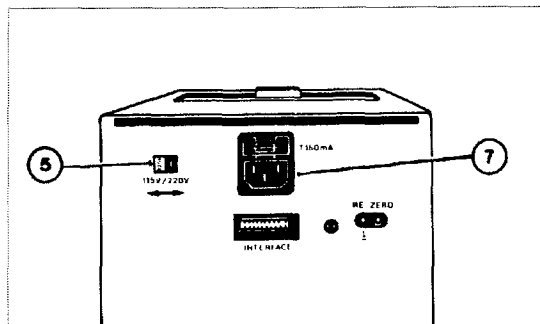

Checking the voltage setting

At the factory, a tag is placed over the power connector (7); the voltage setting is printed on this tag.

If the voltage setting printed on the tag does not agree with the power supply voltage, or if the tag is missing, the setting of the voltage selector switch (5) on the rear wall must be checked, and if needed, changed.

Admissible power supply voltages with switch positions:

115 V:	92 V...132 V
220 V:	184 V...265 V

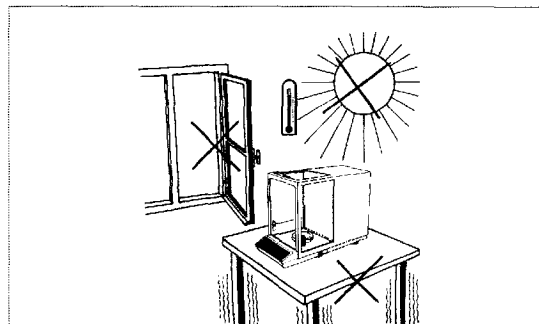

Location

- Stable location; as free from vibration as possible.
- Make sure there are no large temperature fluctuations.
- Avoid a location where there is direct sunlight or drafts.
- Once location is selected, connect the power cable.

If no ideal location can be found using the above criteria, the balance can still provide good results. This can be achieved by following the instructions listed under "Integration time setting and stability detector".

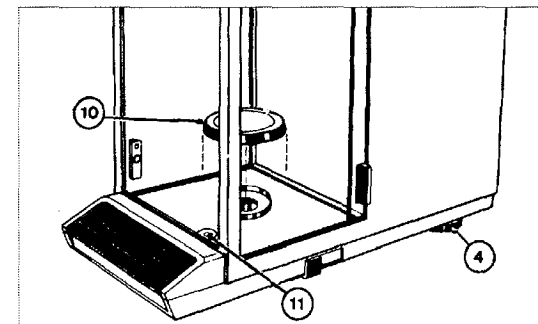

Install pan on balance; level balance

- Install pan (10) on balance; the conical peg is centering it in the middle of the opening on the weighing chamber floor.
- Adjust the two leveling screws (4) so that the bubble in the spirit level (11) is in the middle of the circle.

Any time the balance location is changed, recheck the leveling.

OPERATION: How to switch the balance on, and how to tare

The balance is tared by pressing the single control bar; this bar also turns the display on and off. When switching the balance off by means of the control bar, only the display is turned off. The electronic components are on as long as the power cable is connected (standby). This allows the balance to be operational at all times and eliminates the need for a warm-up time.

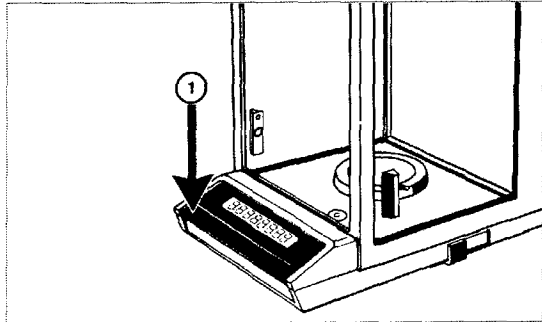

Switching the balance on/off

Switching on:

- Briefly press control bar (1).
All display elements light up for several seconds:
BBBBBBBB
- This permits a functional check of the display.
Then, 0.0000 is displayed.

Switching off:

- Briefly lift control bar.

If the balance displays OFF the control bar must be pressed again briefly.

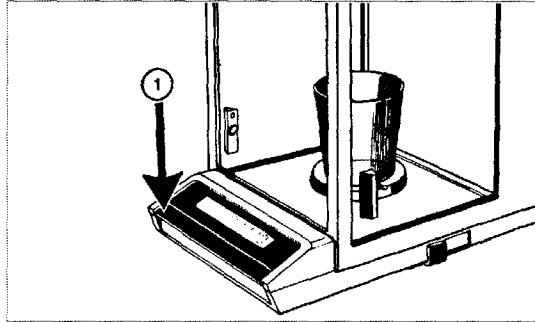

Taring

- Place a container on the pan. Weight is displayed.
 - Briefly press control bar (1).
Display is blanked out, then 0.0000 appears.
- The container weight is now tared out.
The weighing range is now available for weighing-in, minus the tared-out container weight.

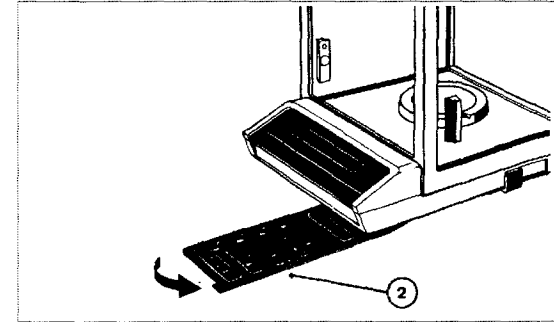

Brief Operating Instructions

Located beneath the balance is a swing-out card (2) on which an abbreviated form of the Operating Instructions are printed.
A detailed procedure (configuration cycle) is illustrated on the next page.

OPERATION: How the single control bar operates.

Your balance is equipped with only one operating bar. This control bar permits the display to be switched on/off, the balance to be configured and weight to be tared. In order to have the balance operate under the most ideal conditions, it must be configured accordingly. The configuration cycle is started by pressing and holding the control bar. The individual configuration modes appear in the display in abbreviated form. After releasing the control bar and then briefly pressing it again, a selection can be made between different steps. (exception: calibrating)

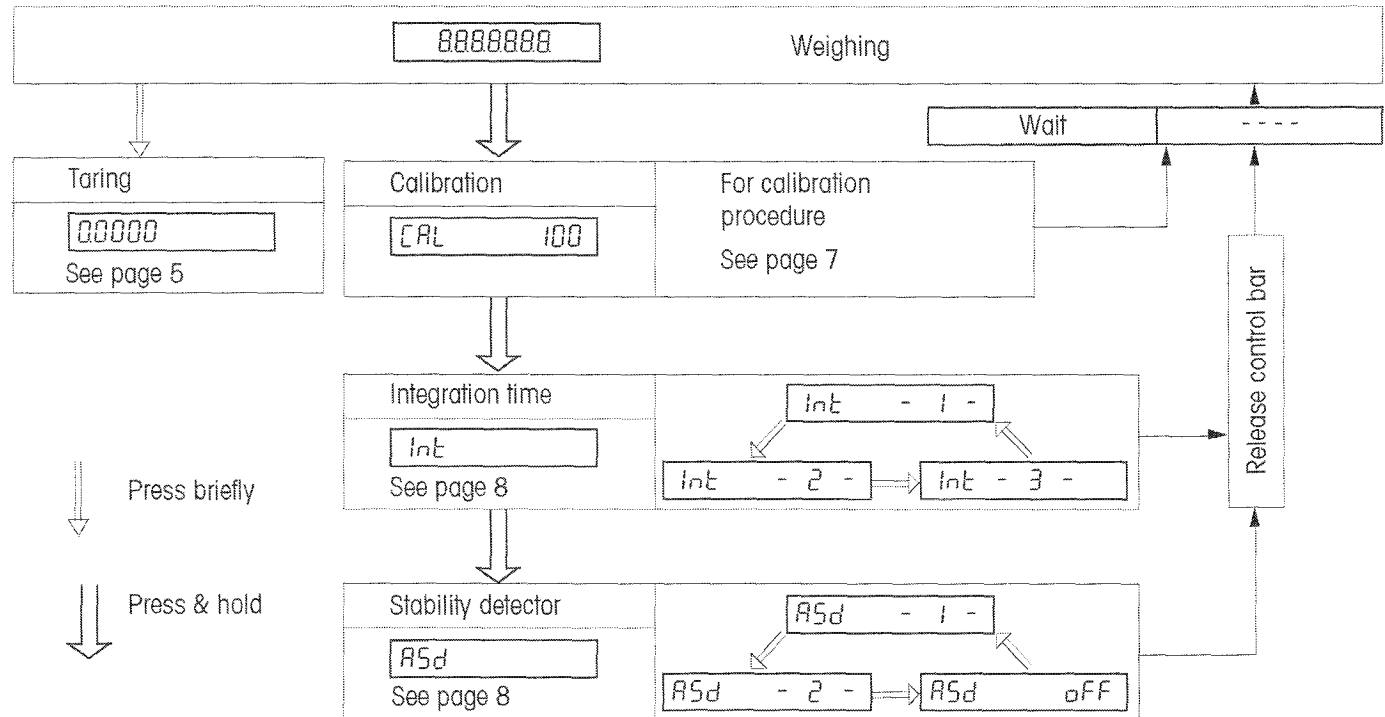

OPERATION: How to calibrate the balance.

Before working with the balance for the first time, it must be calibrated.
Calibration means setting the balance to the correct weight display.

The balance is equipped with a built-in calibration weight (for specifications, see "Technical specifications").

NOTE: to achieve stable results, it is recommended that the balance be left connected to the power supply for 60 minutes prior to calibrating.

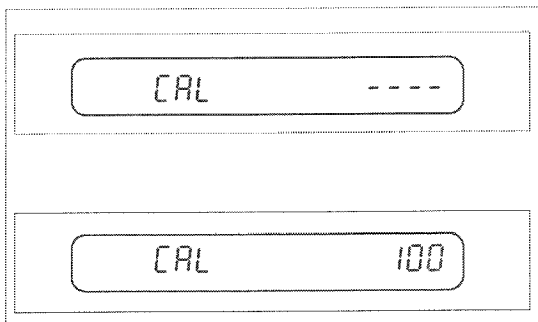

Preparations for calibrating the balance

- Remove all objects from the pan.
- Close the sliding windows.

Set the balance to the calibration mode:

- Press control bar (1) until "CAL" is displayed.
- Release control bar.
"CAL ----", will appear in the display.

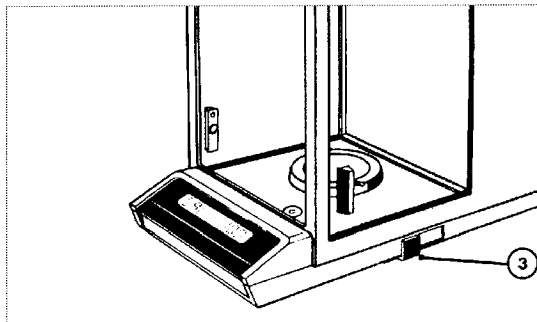

Calibrating the balance

The calibration weight is placed in position by means of the calibration lever (3).

As soon as "CAL 100" appears (the 100 blinks), slowly move the calibration lever towards the rear. First, "CAL ----" appears, then "100.0000". When the display "CAL 0" appears (0 blinks), move lever back to original position. Wait: display "----" followed by "0.0000" appears.

OPERATION: How to set the integration time and the stability detector.

The AE balances are capable of providing excellent results in spite of unfavorable weighing conditions. The stability detector (ASd: automatic stability detection) provides an added measure of reliability to the results.

Setting criteria:	Standard setting	Increased weighing cycle speed	Increased weighing accuracy
	Int : Step 2	Int : Step 1	Int : Step 3
	ASd : Step 2	ASd : Step 2	ASd : Step 1

If the integration time setting or stability detector setting is changed, any previously displayed weighing result will remain unchanged.

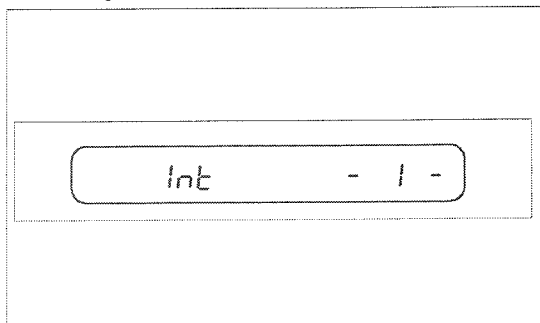

Integration time (Int)

- Press single control bar (1) until balance displays "Int".
- Choice can be made between Steps 1, 2 and 3 by briefly pressing the control bar.

Step 1: shortest time

Once the desired step has been selected, wait until the balance is again in the weighing mode.

If the standard setting is too slow, select Step 1.

If the display is too unstable, select Step 3.

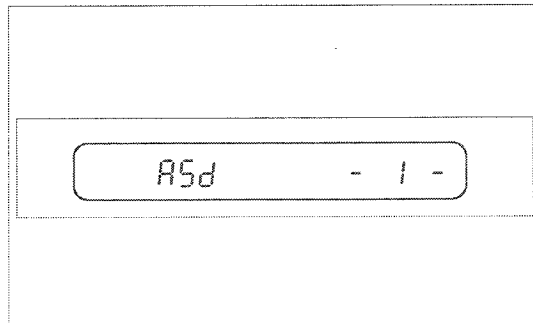

Stability detector (ASd)

- Press single control bar (1) until the balance displays "ASd".
- Choice can be made between Steps 1, 2 or OFF by briefly pressing the single control bar.

Step 1: greatest sensitivity

If use of the stability detector is not wished, it can be turned off ("OFF" position), whereby DeltaDisplay is also switched off.

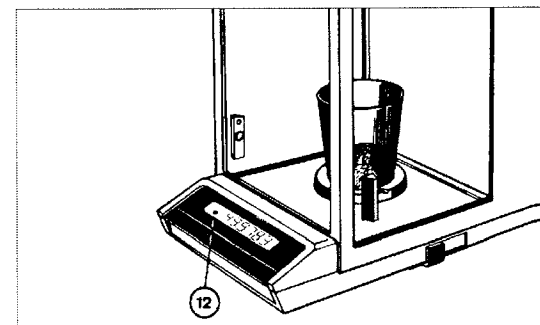

The green pilot light (12) in the left of the display goes off when the balance has achieved stability.

When the pilot lamp is on, the data interface is blocked.

The result should always be read only after the pilot lamp goes out.

OPERATION: How to weigh-in using DeltaDisplay

The AE balances are equipped with DeltaDisplay; this is a display mode which can be switched on and off, and which is especially suitable for weighing-in. When weighing-in, the increasing weight is displayed almost without delay by rapidly changing numbers. In addition, when there are fast weight changes, the last two digits are blanked out to enable you to follow the increasing weight. The stability detector is switched on together with the DeltaDisplay. This permits only stable weight results to be released to the data interface.

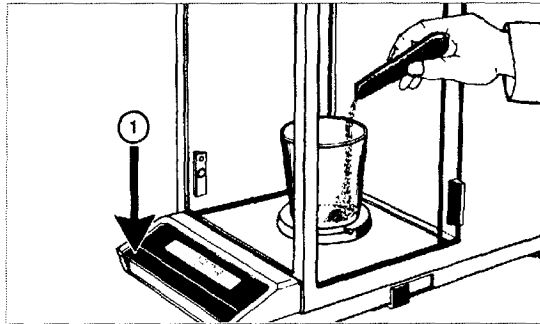

Weighing-in

- Place container on the weighing pan.
- Press control bar (1) to tare: zero display appears.
- Weigh-in up to desired target weight.

If different components must be weighed in, one after the other, tare can be pressed after each component is weighed in, and the next component can be weighed in from zero until the container and all components equal the capacity of the weighing range.

If the weighing range is exceeded, the upper portions of all digits appear: “- - - - -”.

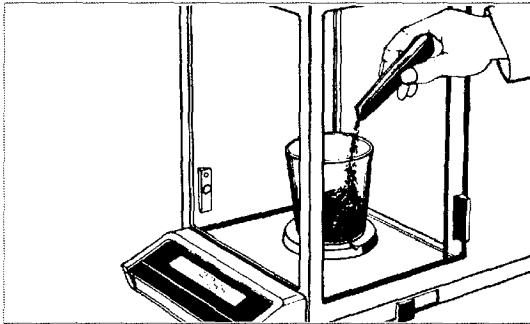

DeltaDisplay

As the component is being filled in quickly, the DeltaDisplay automatically switches in: the last two decimal places (13) are blanked out and the display change is speeded up. This allows the weight increase to be followed better.

DeltaDisplay is switched off when the stability detector (ASd) is configured “OFF”.

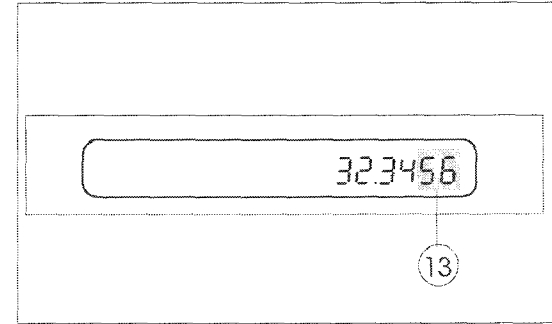

When filling in is slowed down to approach the target weight, the last two digits automatically reappear. The display change continues to be speeded up.

Only when very small weight changes are made, does the balance switch back to the normal display rate.

In this way, a stable weighing result is displayed with full accuracy.

ADDITIONAL BALANCE FUNCTIONS: Below the balance weighing and remote control.

By using a special holder, it is possible to carry out weighings below the weighing chamber through the GD hole.

The holder is not available from METTLER TOLEDO and must be specially made by the customer.

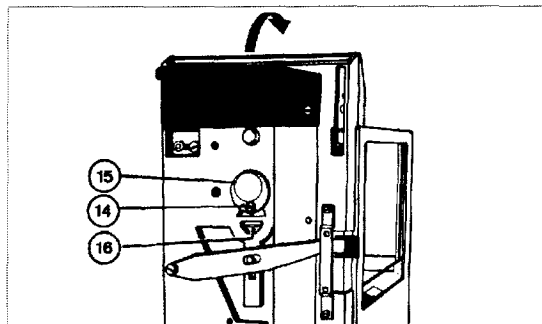

GD hanger

- Open all sliding windows.
- Remove weighing pan.
- Place balance on its back.
- Loosen screw (14) on the bottom of the balance.
- Swing out cover (15).
- Retighten screw (14).

In the opening is a hook (16). A hanger is placed on this hook, and the object to be weighed is placed on the hanger.

- Set balance back on its feet, place pan back on and level balance.
- With the hanger attached, press tare.

The weighing pan does not have to be put back on as long as the holder is at least as heavy as the weighing pan.

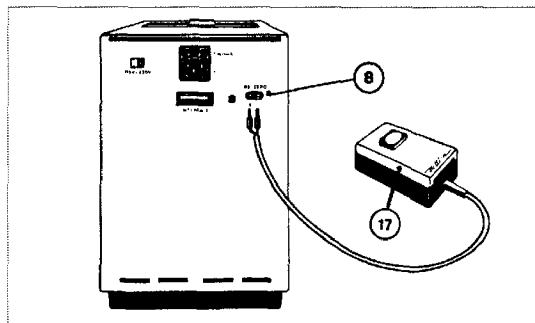

Remote control

Taring can be done by using an external hand key or foot pedal (see Accessories).

- Connect hand key or foot pedal (17) to the sockets (8) on the rear of the balance.

CARE AND MAINTENANCE



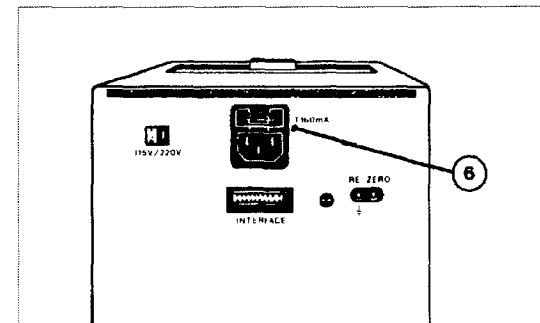



The balance requires very little care and maintenance. A cloth and some soapy water are sufficient for cleaning the weighing pan and balance housing. Do not use any strong solvents. Use the small brush (see Accessories) to remove any foreign material from the weighing chamber. Do not blow air into the chamber under any circumstances!

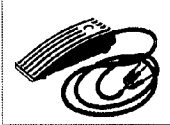
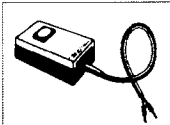

Replacing the microfuse

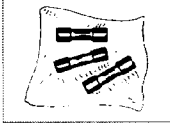
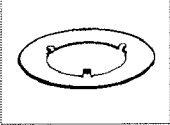
- Disconnect power cable.
- Remove cap (6) with a screwdriver.
- Replace defective fuse (replacement fuse is located in holder).
- Put a new replacement fuse in the holder.
- Place fuse holder back in balance and lightly press in.
- Reconnect power cable.

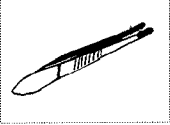
ACCESSORIES

<u>Standard equipment:</u>		<u>Order No.</u>		<u>Order No.</u>
	Power cable neutral Switzerland Germany USA	87576 87920 87925 88668		Foot pedal 46278
<u>Optional equipment:</u>		<u>Order No.</u>		Hand key 42500
	Hair brush	70114		Microfuses: (set of 3) 160 mA
	Centering disk (for draft shield)	38609		Data Interfaces Option 011 (CL/RS232, unidirectional) Option 012 (CL/RS232, bidirectional) Option 013 (IEEE 488)
	Draft shield (can be stacked) 1 section	38594		38750 38751 38752
	Tweezers, 210 mm long (with plastic tips)	70209		
	Density determination kit	40290		

WHAT'S WRONG IF ...

... the entire display does not light up?

... OFF lights up in the display?

... only the upper portions of the display segments light up?

... only the lower portions of the display segments light up?

– the weighing result is unstable?

... the weighing result is obviously incorrect?

THEN ...

- the balance is not switched on
- the power cable is not plugged in
- no power reaching instrument
- a momentary disturbance has occurred (switch balance off and on again or disconnect power cable and plug back in)
- the operating voltage selector has been set incorrectly (correct by following instructions under "Checking the voltage; setting up the balance")
- the microfuse is defective (replace according to instructions under "CARE AND MAINTENANCE"); if fuse blows again, contact METTLER TOLEDO Service.

- the power cable has been disconnected and plugged back in or power was temporarily interrupted (briefly press control bar).

- the weighing range was exceeded
- the calibration weight has been activated (move lever forwards)
- an object was on the weighing pan when the balance was switched on (remove object, switch balance off/on).

- weighing pan is missing (underload)
- an object was on the weighing pan when the balance was switched on (remove object, switch balance off/on).

- too much draft (sliding windows closed?)
- balance location is unstable
- integration time has been set too short
- body heat from hand in weighing chamber
- object to be weighed is not at room temperature.

- tare has not been pressed
- balance not calibrated or calibrated with an incorrect external weight
- operating voltage switch incorrectly set or line voltage has dropped.

WHAT'S WRONG IF ...

- ... only a portion of the display lights up?
- ... the display is locked on one value or nonsense symbols are being displayed?
- ... the middle display sections blinks?
- ... the middle display sections will not stop blinking?
(longer than approx. 30 sec.)
- ... the green pilot lamp for the stability detector does not go out?
- ... only horizontal lines light up in the display during calibration procedure?
- ... CAL 100 blinks?
- ... CAL 0 blinks?
- ... CAL Err appears in the display?
- ... no CAL appears in the display?

THEN ...

- a momentary disturbance has occurred (switch balance off and on again or disconnect power cable and plug back in)
- DeltaDisplay is on.
- operating voltage switch incorrectly set
- line voltage has dropped.
- the balance is in the configuration cycle (wait until 0.0000 appears).
- the weighing location or the load is too unstable (close sliding windows, set longer integration time and/or switch off stability detector).
- the stability detector has been set too sensitively (see instructions under "Integration time and stability detector")
- balance location is unfavorable (drafts, vibrations).
- the weighing location is too unstable (draft; close windows).
- the calibration lever has not been moved towards the rear, or an external calibration weight has not been placed on the pan.
- the calibration lever has not been moved back to original position, or an external calibration weight is still on pan.
- an object was on the weighing pan before beginning calibration procedure, or an incorrect external calibration weight was used (return to weighing mode by pressing and holding control bar).
- a momentary disturbance has occurred (recalibrate balance).

TECHNICAL SPECIFICATIONS

	AE160	AE100
Readability	0.1 mg	0.1 mg
Weighing range	0...162 g	0...109 g
Tare range (subtractive)	0...162 g	0...109 g
Stabilization time (typical)	5 sec.	
Integration time (can be configured: 1/2/3)	1.5/3/6 sec.	
Reproducibility (standard deviation)	0.1 mg	
Linearity	± 0.2 mg	
Linearity relative to 10 g	± 0.1 mg	
Admissible ambient temperature during operation	10...40 °C	
Sensitivity drift 10...30 °C	± 2·10 ⁻⁶ /°C	
Stability detector (can be configured)	2 sensitivity steps / switched off	
Power supply:		
– Voltage, adjustable	115 V / 220 V	
– Admissible voltage range	92...132 V / 184...265 V	
– Frequency	50...60 Hz	
– Power consumption	approx. 10 VA	
Weighing pan of stainless steel	∅ 80 mm	
Weighing chamber (width x depth x height)	172 x 155 x 220 mm	
Balance housing (width x depth x height)	205 x 410 x 290 mm	
Net weight	10.3 kg	
Calibration weight (built-in)	100 g, ± 0.2 mg,	adjusted to an apparent mass of 8.0 g/cm ³ density at an air density of 1200 mg/l.